

# ISO TUBI

STAINLESS STEEL  
PIPES AND FITTINGS

## CATÁLOGO DE PRODUCTOS NUMEPRESS 304

MAT. 1.4301

TUBOS Y ACCESORIOS  
PRENSADOS DE  
ACERO INOXIDABLE



Mayo 2023

[isotubi.com](http://isotubi.com)

\*Consultar siempre nuestra página web  
para la edición más reciente

INTRODUCCIÓN	03
PRINCIPALES MÁQUINAS DE PRENSADO	04
CONDICIONES GENERALES DE VENTA	05
FIG 01 MANGUITO	06
FIG 02 MANGUITO DE ALARGO	06
FIG 03 CODO 90° H-H	06
FIG 04 CODO 90° H-M	07
FIG 05 CODO 45° H-H	07
FIG 06 CODO 45° H-M	07
FIG 07 CODO HEMBRA ROSCA HEMBRA	08
FIG 08 CODO HEMBRA ROSCA MACHO	08
FIG 09 CODO PLACA	08
FIG 10 CODO DE AJUSTE 90°	09
FIG 12 TE SALIDA CENTRAL ROSCA	09
FIG 14 REDUCCIÓN	10
FIG 15 TE SALIDA CENTRAL REDUCIDA	11
FIG 16 TE IGUAL	12
FIG 17 ENTRONQUE HEMBRA	12
FIG 18 ENTRONQUE MACHO	13
FIG 19 BRIDA ADAPTADOR	13
FIG 20 CURVA DESVÍO	14
FIG 21 TAPÓN	14
FIG 22 BAJANTE DESVÍO DOBLE	14
FIG 36 TE SALIDA CENTRAL ROSCA MACHO	15
FIG 45 TUERCA HEMBRA 2 PIEZAS	15

# INTRODUCCIÓN



En Isotubi S.L. fabricamos tubería soldada y accesorios pressfitting de acero inoxidable desde hace más de 40 años. Plenamente consolidados en el mercado internacional, ofrecemos a nuestros clientes un producto capaz de alcanzar las más altas exigencias de calidad de las principales normas internacionales.

El conocimiento de las necesidades de nuestros clientes, una voluntad constante de adaptación a las nuevas tecnologías y un esfuerzo continuo en mejorar el servicio al cliente son los objetivos de nuestro equipo humano.

Nuestros procesos productivos y el sistema de calidad, certificado por TÜV de acuerdo a las normas internacionales ISO 9001 e ISO 14001 avalan la calidad, fiabilidad y sostenibilidad de nuestros productos. También disponemos de los principales certificados de calidad europeos.

Todo ello gracias a nuestro equipo humano, en el que se unen experiencia y juventud, y en el que la ilusión por mejorar, el esfuerzo y el trabajo diario constituyen nuestra base de trabajo. Isotubi forma parte del Grupo Lapuente, experto en productos y servicios en acero inoxidable.

## NUESTRO PRODUCTO NUMEPRESS

Les presentamos en este catálogo nuestra gama de productos **NUMEPRESS**, sistema de tubería y accesorios para presar en acero inoxidable, que permite, de un modo fácil y rápido, realizar instalaciones sin roscas y sin soldaduras y con un considerable ahorro de tiempo y mano de obra.

Nuestra fábrica y nuestro almacén, con un stock importante a su disposición, nos permite satisfacer de un modo rápido las necesidades del cliente, ya sean en la gama estándar de productos, o en aquellos fabricados a medida.

Las principales aplicaciones de nuestro producto permiten cubrir una amplia gama de sectores: aire comprimido, calefacción, climatización, sistemas contra incendios, energía solar, agua, industria, naval, minería y gas.



**Nuestros  
Departamentos  
Técnico y Comercial están  
a su disposición para  
cualquier consulta que  
pudiesen necesitar.**

La herramienta de prensar puede ser manual, con batería o eléctrica. Para cada diámetro existe la correspondiente mordaza fácilmente intercambiable que debe ser introducida en el cilindro de la herramienta.

La mayoría de las máquinas existentes en el mercado pueden prensar accesorios **NUMEPRESS** desde el diámetro 15 mm hasta 54 mm, pero deberemos asegurarnos que la fuerza de prensado es al menos 32 kN y la mordaza de perfil M.

Para las dimensiones de 76,1 a 168,3 existen otras máquinas con mayor fuerza de prensado.



Datos técnicos	UAP4L	MAP2L19	UAP100L	ACO203XL	ACO 401
Fuente de alimentación	18 V / 3 Ah	1.5 Ah / 3 Ah	18 V / 3 Ah	18 V / 3,0 Ah Li-Ion	18 V / 3 Ah
Potencia	-	-	-	450 W	400 W
Dimensiones (L x W x H)	512 x 81 x 317 mm	370 x 75 x 116 mm	567 x 81 x 359 mm	460 x 83 x 113 mm	660 x 100 x 250 mm
Peso	4,3 Kg	3,1 Kg	12,7 Kg	3,9 Kg	13 Kg
Fuerza del pistón	32 kN	19 kN	120 kN	32 kN	100 kN

## CONDICIONES GENERALES DE VENTA ISOTUBI, S.L.

1. Las ventas efectuadas por Isotubi, S.L. quedan sujetas a las condiciones de venta especificadas a continuación, de no mediar renuncia expresa por parte de Isotubi para algunas de las cláusulas en caso de pedidos especiales.
2. Los precios deben consultarse en nuestro manual de tarifas vigente en el momento de efectuar el pedido. Isotubi se reserva el derecho a modificar las tarifas en caso de oscilaciones de mercado.
3. Isotubi no se responsabiliza en ningún caso del transporte. Las mercancías viajan siempre por cuenta y riesgo del comprador, incluso si son enviadas “franco destino”.
4. Isotubi establecerá anualmente el importe mínimo del pedido a partir del cual los costes del transporte serán a cargo del vendedor. La unidad mínima de venta es de una bolsa completa.
5. El plazo de entrega indicado en las confirmaciones de pedido únicamente tiene carácter indicativo.
6. El vendedor se reserva el derecho de enviar una cantidad no inferior ni superior a un 10% a la inicialmente pedida por el cliente, salvo en aquellos casos en que quede especificada la negativa por escrito.
7. La falta de pago de una factura a su vencimiento dará derecho a Isotubi a la paralización de la entrega de cualquier pedido posterior que pudiera estar pendiente de servir hasta que la situación quede regularizada.  
En caso de persistencia del impago, el vendedor se reserva el derecho a emprender las acciones legales necesarias.
8. Isotubi no aceptará devoluciones de material una vez transcurridos 15 días desde la fecha entrega. En toda devolución será obligatorio adjuntar el material devuelto, la documentación de entrega y un informe de los defectos observados en el material.  
En el caso de reconocer como defectuoso el material devuelto, Isotubi procederá a su restitución, quedando exentos de cualquier otro daño o perjuicio. No se aceptará reclamación o devolución alguna cuando el material haya sido objeto de manipulación por parte del comprador.  
Isotubi garantiza el sistema NUMEPRESS salvo en aquellos casos en los que el material utilizado en las instalaciones no sea en su totalidad fabricado por Isotubi.
9. Los accesorios NUMEPRESS se entregan con junta EPDM (negra) salvo los accesorios para Gas, que se entregan con junta HNBR (amarilla).

FIG.01



MAT: AISI 304

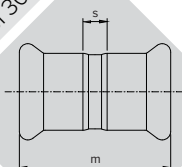

FIG.02



MAT: AISI 304

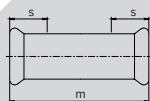
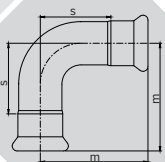

FIG.03



MAT: AISI 304



### MANGUITO

Dimensiones	m	s	Nº piezas/Bolsas	Art. Nº
15	49	8	20	F01154
18	50	8	20	F01184
22	50.5	8	20	F01224
28	55	8	20	F01284
35	70	18	10	F01354
42	78	18	4	F01424
54	85.5	18	4	F01544
76.1	140.5	33	1	F01764
88.9	160	45	1	F01884
108	197	58	1	F011084
139.7	250	54	1	F0113924
168.3	300	64	1	F0116824

### MANGUITO DE ALARGO

Dimensiones	m	s	Nº piezas/Bolsas	Art. Nº
15	80	27.5	20	F02154
18	80	27.5	20	F02184
22	71	19.5	20	F02224
28	84	22	20	F02284
35	99	26	10	F02354
42	114	30	4	F02424
54	136	34	4	F02544
76.1	226	54	1	F02764
88.9	255	58	1	F02884
108	300	71.5	1	F021084

### CODO 90° H-H

Dimensiones	m	s	Nº piezas/Bolsas	Art. Nº
15	48	28	20	F03154
18	52	32	20	F03184
22	61	40	20	F03224
28	71.5	49	10	F03284
35	74	48	10	F03354
42	86	56	4	F03424
54	105.5	71.5	2	F03544
76.1	177	123.5	1	F03764
88.9	181	123	1	F03884
108	214	140	1	F031084
139.7	314	216	1	F0313924
168.3	386	268	1	F0316824

## CODO 90° H-M

Dimensiones	m	h	s	N° piezas/Bolsas	Art. N°
15	48	67	28	20	F04154
18	52	65	32	20	F04184
22	61	74	40	20	F04224
28	71.5	82	49	10	F04284
35	74	85	48	10	F04354
42	86	96.5	56	4	F04424
54	105	113.5	71.5	2	F04544
76.1	177	195	123.5	1	F04764
88.9	181	202	123	1	F04884
108	214	240	140	1	F041084
139.7	314	322	216	1	F0413924
168.3	386	404	268	1	F0416824

FIG.04



## CODO 45° H-H

Dimensiones	m	s	N° piezas/Bolsas	Art. N°
15	34.5	14.5	20	F05154
18	36	16	20	F05184
22	41	20	20	F05224
28	46	24	10	F05284
35	49.4	23.4	10	F05354
42	56.7	26.7	4	F05424
54	66.5	33	2	F05544
76.1	111	57.5	1	F05764
88.9	114	56	1	F05884
108	138	64	1	F051084
139.7	203	105	1	F0513924
168.3	252	134	1	F0516824

FIG.05



## CODO 45° H-M

Dimensiones	m	h	s	N° piezas/Bolsas	Art. N°
15	34.5	47	14.5	20	F06154
18	36	48.5	16	20	F06184
22	41.0	52	20	20	F06224
28	46	58	24	10	F06284
35	49.4	60.4	23.4	10	F06354
42	56.7	69.7	26.7	4	F06424
54	66.5	75.4	33	2	F06544
76.1	111	128	57.5	1	F06764
88.9	114	135	56	1	F06884
108	138	169	64	1	F061084
139.7	203	210	105	1	F0613924
168.3	252	253	134	1	F0616824

FIG.06

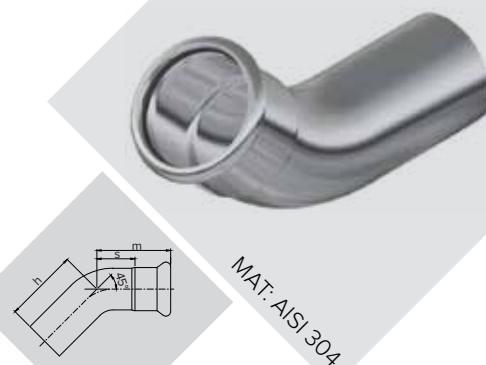

**FIG.07**



MAT: AISI 304

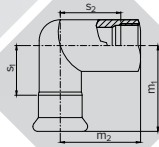

**CODO HEMBRA ROSCA HEMBRA**

Dimensiones	m <sub>1</sub>	m <sub>2</sub>	s <sub>1</sub>	s <sub>2</sub>	Nº piezas/Bolsas	Art. Nº
15-Rp 1/2"	57	37	37	24	20	F07151/24
18-Rp 1/2"	57	39	37	26	20	F07181/24
18-Rp 3/4"	59	46	39	31	10	F07183/44
22-Rp 3/4"	61,0	46	39	31	10	F07223/44
28-Rp 1"	67	54	44	37	10	F072814
35-Rp 1 1/4"	75	63	49	44	10	F073511/44

**FIG.08**



MAT: AISI 304

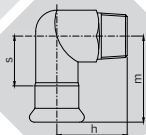

**CODO HEMBRA ROSCA MACHO**

Dimensiones	m	h	s	Nº piezas/Bolsas	Art. Nº
15-R 1/2"	57	37	37	20	F08151/24
18-R 1/2"	57	39	37	20	F08181/24
18-R 3/4"	59	46	39	10	F08183/44
22-R 3/4"	61,0	46	39	10	F08223/44
28-R 1"	67	54	44	10	F082814
35-R 1 1/4"	75	63	49	10	F083511/44
42-R 1 1/2"	84	67	54	2	F084211/24
54-R 2"	93	78	60	2	F085424

**FIG.09**



MAT: AISI 304

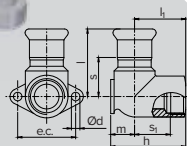

**CODO PLACA**

Dimensiones	m	h	l <sub>1</sub>	l	Ød e.c.	s	s <sub>1</sub>	Nº piezas/Bolsas	Art. Nº	
NW-15-Rp 1/2"	14	44	30	50	5	34	28	17	20	F09151/24
NW-18-Rp 1/2"	14	44	30	50	5	34	30	17	20	F09181/24
NW-22-Rp 3/4"	18	52,0	34	55,0	6	40	33	20	20	F09223/44



## CODO DE AJUSTE 90°

Dimensiones	$h_1$	$h_{1min.}$	$h_2$	$h_{2min.}$	Nº piezas/Bolsas	Art. Nº
15	70	58	120	58	20	F10154
18	70	63	120	63	20	F10184
22	70	70	120	70	10	F10224
28	80	80	120	80	10	F10284
35	120	100	200	100	4	F10354
42	150	120	250	120	2	F10424
54	200	145	300	145	2	F10544
76.1	195	-	195	-	1	F10764
88.9	202	-	202	-	1	F10884
108	240	-	240	-	1	F101084

FIG.10



MAT: AISI 304

## TE SALIDA CENTRAL ROSCA

Dimensiones	$m_1$	$m_2$	$s_1$	$s_2$	(*)	Art. Nº
15-Rp 1/2"-15	32	36	12	23	20	F12151/24
18-Rp 1/2"-18	34	37	14	24	20	F12181/24
18-Rp 3/4"-18	34	41	14	26	20	F12183/44
22-Rp 1/2"-22	37,5	39	16	26	20	F12221/24
22-Rp 3/4"-22	37,5	44	16	29	20	F12223/44
28-Rp 1/2"-28	41	42	19	29	10	F12281/24
28-Rp 3/4"-28	41	46	19	31	10	F12283/44
28-Rp 1"-28	41	47	19	30	10	F122814
35-Rp 1/2"-35	50	45	24	32	10	F12351/24
35-Rp 3/4"-35	50	50	24	35	10	F12353/44
35-Rp 1"-35	50	51	24	34	10	F123514
35-Rp 1 1/4"-35	50	55	24	36	10	F123511/44
42-Rp 1/2"-42	57	48	27	35	4	F12421/24
42-Rp 3/4"-42	57	52	27	37	4	F12423/44
42-Rp 1"-42	57	53	27	34	4	F124214
42-Rp 1 1/2"-42	57	61	27	42	4	F124211/24
54-Rp 1/2"-54	68	55	34	41	2	F12541/24
54-Rp 3/4"-54	68	58	34	43	2	F12543/44
54-Rp 1"-54	68	59	34	41	2	F125414
54-Rp 2"-54	68	76	34	47	2	F125424
76.1-Rp 3/4"-76.1	113	71	59	56	1	F12763/44
76.1-Rp 2"-76.1	113	91	59	62	1	F127624
88.9-Rp 3/4"-88.9	128	78	70	63	1	F12883/44
88.9-Rp 2"-88.9	128	97	70	68	1	F128824
108-Rp 3/4"-108	150	87	81	72	1	F121083/44
108-Rp 2"-108	150	107	81	78	1	F1210824
139.7-2"-139.7	197	123	99	94	1	F12139224
139.7-3/4-139.7	197	105,5	99	90,5	1	F121393/424

FIG.12



MAT: AISI 304

(\*) Nº piezas/Bolsas

**REDUCCIÓN**

**FIG.14**



MAT: AISI 304

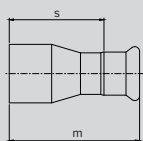

Dimensiones	m	s	(*)	Art. Núm
18-15	62	42	20	F1418154
22-15	64	44	20	F1422154
22-18	60	40	20	F1422184
28-15	68	48	20	F1428154
28-18	66	46	20	F1428184
28-22	65	45.5	20	F1428224
35-15	77	57	10	F1435154
35-18	77	57	10	F1435184
35-22	82,5	61.5	10	F1435224
35-28	74	52	10	F1435284
42-15	85	65	4	F1442154
42-18	87	67	4	F1442184
42-22	88,0	66.5	4	F1442224
42-28	82	60	4	F1442284
42-35	88	62	4	F1442354
54-15	92	72	4	F1454154
54-18	93	72,0	4	F1454184
54-22	93,5	72.5	4	F1454224
54-28	93	71	4	F1454284
54-35	101	75	4	F1454354
54-42	101	71	4	F1454424
76.1-22	122	100.5	1	F1476224
76.1-28	123	101	1	F1476284
76.1-35	126	100	1	F1476354
76.1-42	130	100	1	F1476424
76.1-54	132	98	1	F1476544
88.9-42	159	129	1	F1488424
88.9-54	162	128	1	F1488544
88.9-76.1	185	131	1	F1488764
108-54	179	145	1	F14108544
108-76.1	198	145	1	F14108764
108-88.9	206	148	1	F14108884
139.7-76.1	347	293	1	F141397624
139.7-88.9	340	282	1	F141398824
139.7-108	307	236	1	F1413910824
168.3-76.1	278	210	1	F141687624
168.3-88.9	379	321	1	F141688824
168.3-108	360	289	1	F1416810824
168.3-139.7	422	324	1	F1416813924

(\*) N°piezas/Bolsas

## TE SALIDA CENTRAL REDUCIDA

Dimensiones	m <sub>1</sub>	m <sub>2</sub>	s <sub>1</sub>	s <sub>2</sub>	(*)	Art. N°
18-15-18	34	40	14	20	20	F151815184
22-15-22	37.5	42	16	22	20	F152215224
22-18-22	37.5	42	16	22	20	F152218224
28-15-28	41	45	19	25	10	F152815284
28-18-28	41	45	19	25	10	F152818284
28-22-28	41	46,5	19	25	10	F152822284
35-15-35	50	48	24	28	10	F153515354
35-18-35	50	48	24	28	10	F153518354
35-22-35	50	49,0	24	28	10	F153522354
35-28-35	50	51	24	28	10	F153528354
42-15-42	57	51.5	27	31.5	4	F154215424
42-18-42	57	52	27	31	4	F154218424
42-22-42	57	52,0	27	31	4	F154222424
42-28-42	57	53	27	31	4	F154228424
42-35-42	57	57	27	31	4	F154235424
54-15-54	68	56.5	34	37.5	2	F155415544
54-18-54	68	56.5	34	37.5	2	F155418544
54-22-54	68	58,0	34	37.5	2	F155422544
54-28-54	68	60	34	38	2	F155428544
54-35-54	68	63	34	37	2	F155435544
54-42-54	68	67	34	37	2	F155442544
76.1-22-76.1	113	76,5	59	48	1	F157622764
76.1-28-76.1	113	72	59	49	1	F157628764
76.1-35-76.1	113	74	59	48	1	F157635764
76.1-42-76.1	113	76	59	46	1	F157642764
76.1-54-76.1	113	83	59	46.7	1	F157654764
88.9-22-88.9	128	75	72	55	1	F158822884
88.9-28-88.9	128	79	72	56	1	F158828884
88.9-35-88.9	128	81	72	55	1	F158835884
88.9-42-88.9	128	83	72	53	1	F158842884
88.9-54-88.9	128	90	72	53.7	1	F158854884
88.9-76.1-88.9	128	115	72	63	1	F158876884
108-22-108	150	86,0	81	64	1	F15108221084
108-28-108	150	88	81	65	1	F15108281084
108-35-108	150	90	81	64	1	F15108351084
108-42-108	150	95	81	65	1	F15108421084
108-54-108	150	99	81	65	1	F15108541084
108-76.1-108	150	126.5	81	73	1	F15108761084
108-88.9-108	150	136	81	74	1	F15108881084
139.7-76.1-139.7	197	143	99	88	1	F151397613924
139.7-88.9-139.7	197	153	99	95	1	F151398813924
139.7-108-139.7	197	167	99	96	1	F1513910813924
168.3-76.1-168.3	257	157	139	103	1	F151687616824
168.3-88.9-168.3	257	167	139	110	1	F151688816824
168.3-108-168.3	257	182	139	111	1	F1516810816824
168.3-139.7-168.3	257	211	139	113	1	F1516813916824

FIG.15



(\*) N°piezas/Bolsas

**FIG.16**



MAT: AISI 304

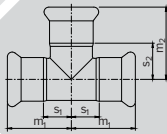

**TE IGUAL**

Dimensiones	m <sub>1</sub>	m <sub>2</sub>	s <sub>1</sub>	s <sub>2</sub>	Nº piezas/Bolsas	Art. Nº
15	32	39	12	19	20	F16154
18	34	39	14	19	20	F16184
22	37.5	43,0	16	22,0	20	F16224
28	41	47	19	25	10	F16284
35	50	53	24	27	10	F16354
42	57	60	27	30	4	F16424
54	68	71	34	37	2	F16544
76.1	113	110	59	55	1	F16764
88.9	128	128	72	69	1	F16884
108	150	154	81	85	1	F161084
139.7	197	197	99	99	1	F1613924
168.3	257	235	139	118	1	F1616824

**FIG.17**



MAT: AISI 304

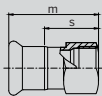

**ENTRONQUE HEMBRA**

Dimensiones	m	s	Nº piezas/Bolsas	Art. Nº
15-Rp 3/8"	54	34	20	F17153/84
15-Rp 1/2"	54	34	20	F17151/24
15-Rp 3/4"	58	38	20	F17153/44
18-Rp 1/2"	54	34	20	F17181/24
18-Rp 3/4"	58	38	20	F17183/44
22-Rp 1/2"	54,0	32.5	20	F17221/24
22-Rp 3/4"	59,0	38	20	F17223/44
22-Rp 1"	60,0	39.5	20	F172214
28-Rp 3/4"	60	38	20	F17283/44
28-Rp 1"	60.5	38.5	20	F172814
28-Rp 1 1/4"	65	43	20	F172811/44
35-Rp 1"	64	38	10	F173514
35-Rp 1 1/4"	69	43	10	F173511/44
35-Rp 1 1/2"	73	47	10	F173511/24
42-Rp 1 1/4"	72	42	4	F174211/44
42-Rp 1 1/2"	77	47	4	F174211/24
54-Rp 1 1/2"	81	47	4	F175411/24
54-Rp 2"	90	56	4	F175424
76.1-Rp 2 1/2"	129	75.5	1	F177621/24
88.9-Rp 3"	118	60.5	1	F178834

## ENTRONQUE MACHO

Abmessung	m	s	N° piezas/Bolsas	Art. N°
15-R 3/8"	48	28	20	F18153/84
15-R 1/2"	53.5	33.5	20	F18151/24
15-R 3/4"	57.5	37.5	20	F18153/44
18-R 1/2"	53.5	33.5	20	F18181/24
18-R 3/4"	58	38	20	F18183/44
22-R 1/2"	54,5	33.5	20	F18221/24
22-R 3/4"	58,5	37.5	20	F18223/44
22-R 1"	62.0	41	20	F182214
28-R 3/4"	60	38	20	F18283/44
28-R 1"	63	41	20	F182814
28-R 1 1/4"	67	45	20	F182811/44
35-R 1"	67	41	10	F183514
35-R 1 1/4"	71	45	10	F183511/44
35-R 1 1/2"	74	48	10	F183511/24
42-R 1 1/4"	75	45	4	F184211/44
42-R 1 1/2"	78	48	4	F184211/24
54-R 1 1/2"	82	48	4	F185411/24
54-R 2"	84	50	4	F185424
76.1-R 2 1/2"	127.5	74	1	F1821/24
88.9-R 3"	142	86	1	F188834
108-R 4"	155	73	1	F1810844

FIG.18

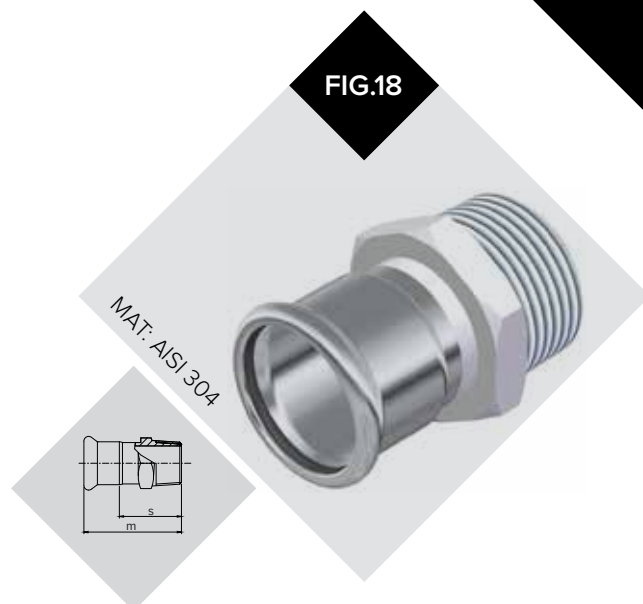

## BRIDA ADAPTADOR

Dimensiones	D	k	b	d <sub>2</sub>	h	n*	z	(*)	Art. N°
15-DN 15	95	65	14	14	45	4	25	1	F19154
18-DN 15	95	65	14	14	47	4	27	1	F19184
22-DN 20	105	75	16	14	52	4	31	1	F19224
28-DN 25	115	85	16	14	56	4	34	1	F19284
35-DN 32	140	100	18	18	66	4	40	1	F19354
42-DN 40	150	110	18	18	74	4	44	1	F19424
54-DN 50	165	125	18	18	85	4	51	1	F19544
76.1-DN 65	185	145	20	18	132	4	78	1	F19764
88.9-DN 80	200	160	20	18	146	8	91	1	F19884
108-DN 100	220	180	20	18	169	8	100	1	F191084

FIG.19



n\* = Número de tal. de Ø d<sub>2</sub>  
 (\*) N° piezas/Bolsas

**FIG.20**



MAT: AISI 304

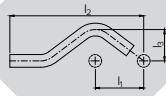

**FIG.21**



MAT: AISI 304

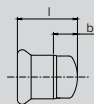

**FIG.22**



MAT: AISI 304

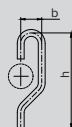

## CURVA DESVÍO

Dimensiones	$l_1$	$l_2$	$l_3$	Nº piezas/Bolsas	Art. Nº
15	57	158	37	20	F20154
18	60	165	40	20	F20184
22	65	178	44	20	F20224
28	74	210	50	10	F20284

## TAPÓN

Dimensiones	l	b	Nº piezas/Bolsas	Art. Nº
15	36	16	20	F21154
18	36	16	10	F21184
22	41,5	21,5	10	F21224
28	42	20	10	F21284
35	51	25	10	F21354
42	54	24	4	F21424
54	59	25	4	F21544
76.1	90	36	1	F21764
88.9	102	45	1	F21884
108	125	56	1	F211084

## BAJANTE DESVÍO DOBLE

Dimensiones	b	h	Nº piezas/Bolsas	Art. Nº
15	46	208	10	F23154
18	54	218	10	F23184
22	68	246	10	F23224
28	86	283	10	F23284

## TE SALIDA CENTRAL ROSCA MACHO

Dimensiones	m <sub>1</sub>	m <sub>2</sub>	s <sub>1</sub>	s <sub>2</sub>	Nº piezas/Bolsas	Art. Nº
15-R 3/8"	32	34.5	12	21.5	20	F36153/84
15-R 1/2"	32	36	12	21	20	F36151/24
18-R 1/2"	34	36.5	14	21.5	20	F36181/24
18-R 3/4"	34	40.5	14	23.5	20	F36183/44
22-R 3/4"	35.5	43.5	16	26.5	20	F36223/44
28-R 1"	41	49.5	19	29.5	10	F362814
35-R 1 1/4"	50	56.5	24	34.5	10	F363511/44

FIG.36

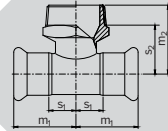

## TUERCA HEMBRA 2 PIEZAS

Dimensiones	m	s	Nº piezas/Bolsas	Art. Nº
15-1/2"	63.5	34.5	20	F45151/24
15-3/4"	46	19.5	20	F45153/44
18-1/2"	65.5	34.5	20	F45181/24
18-3/4"	48	21.5	20	F45183/44
22-3/4"	65	36.5	20	F45223/44
22-1"	50.5	23.5	20	F452214
28-1"	73	39.5	20	F452814
28-1 1/4"	58	27.5	20	F452811/44
35-1 1/4"	76	38	10	F453511/44
35-1 1/2"	66.5	32	10	F453511/24
42-1 1/2"	82.5	41	4	F454211/24
42-2"	75	35.5	4	F454224
54-2"	91	47	2	F455424

FIG.45

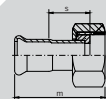



**ISOTUBI**  
STAINLESS STEEL  
PIPES AND FITTINGS

Oficinas / Almacén: Av. Can Campanyà, 15  
Pol. Ind. Comte de Sert 08755 Castellbisbal  
Barcelona • Spain  
Almacén: C/Gibraltar, 12 • Pol. Ind. Fuente del Jarro  
46988 Paterna (Valencia). Spain  
Tel. + 34 93 771 16 97 • Fax. + 34 93 772 19 43  
[isotubi@isotubi.com](mailto:isotubi@isotubi.com) • [www.isotubi.com](http://www.isotubi.com)